

User's Manual

DIGITAL PIANO

SONATA 88

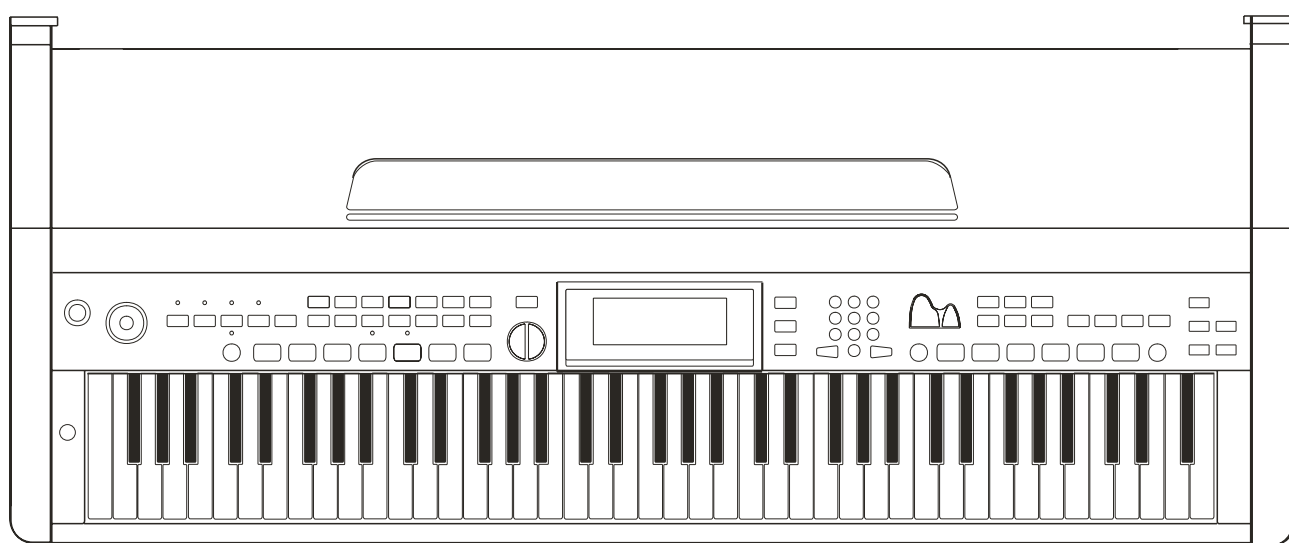

W W
W I L L I A M S

Using the Instruction Manual

Thank you for purchasing this Digital Piano. The use of high technology and the most advanced sampling technique brings you high quality sound and enjoyment. The combination of digital piano and electronic keyboard features let you perform perfectly. We hope this skilfully built digital piano will able to explore your creativity, and brings you unlimited happiness and music enjoyment. Before you use the piano, we recommend you to read through this manual. Please keep this instruction manual for future reference.

Precautions

Please read the following carefully before use:

- Do not expose the piano to high temperature, direct sunlight and excessively dusty places.
- Do not place the piano too close to other electrical appliances such as television and radio or it may cause interference.
- Do not place the piano to excessive humidity area. Avoid putting container with liquid on top of the piano, this will prevent the damage of the internal parts of the piano by flowing liquid.
- Always unplug cables by gripping the plug firmly, but not pulling on the cable.
- Do not apply excessive force to the switches and buttons.
- When the piano is not in use or during a thunderstorm, disconnect the power supply.
- Avoid adjusting the volume level to the maximum or to the levels that you feel uncomfortable, we recommend you to limit the volume level to two-third of the max to prevent the damage of auditory sense
- Unplug the power cable before cleaning the piano, never connect or disconnect the power cable with a wet hand.
- Check and clean the power plug periodically.
- To avoid damage to the piano and other devices to which it is connected, turn the power switches of all related device off prior to connecting or disconnecting cables.
- Clean the piano with a dry soft cloth, a slightly damp cloth may be used to remove dirt.
- Never use cleaners such as thinner or alcohol. To prevent damage the surface of the LCD display, please use lens cleaning tissue to clean the display.
- If the piano cable is damaged, do not use the piano, otherwise it may a fire or electrical hazard.
- The piano may cause malfunction due to improper handling, if this occurs, switch off the piano and switch on again after 30 seconds.
- Do not attempted to disassemble or repair the piano by yourself, and do not modify the internal parts. If the piano is not working properly, please contact approved repairer.

Contents

Digital Piano Set-up Guide	3-5
General Guide	6-7
The Connectors	8-9
- Using the AC power jack.....	8
- Using headphones.....	8
- Using AUX.OUT jack.....	8
- Using the foot pedals.....	9
- Using the MIDI IN/OUT jacks.....	9
Basic Operation	10
1. Power switch & volume.....	10
2. Demonstration.....	10
Voice and Effects	10-13
1. Select a voice.....	10
2. Dual voice.....	11
3. Harmony.....	11
4. Drum kit.....	12
5. Digital effects.....	12
6. Instant select piano voice.....	13
Touch Response Keyboard	13
Octave Down Control	13
Split Keyboard	14
Playing the Styles	14-16
1. Select a style.....	14
2. The chord recognition modes.....	15
3. Accompaniment control.....	16
Metronome	17
Jam Track	17
One Touch Setting	18
Selecting the One Touch Setting.....	18
The Sequencer	19
Playback the recorded song.....	19
Record a new song.....	19
Mixer Volume Control	20
Muting the sections.....	20
Utility Functions	20-21
- Change the Tempo.....	20
- Restoring the memorized Tempo.....	20
- Pan.....	21
- Pitch.....	21
- Transpose.....	21

MIDI	22
- MIDI channel selection.....	22
- Control change filter.....	22
Specifications	23
Troubleshooting	23
Appendix	24-27
- Appendix 1A - Single Finger Chord Chart.....	24
- Appendix 1B - Fingered Chord Chart.....	25
- Appendix 2 - Style List.....	25
- Appendix 3 - Voice List.....	25
- Appendix 4 - Demo Song List.....	26
- Appendix 5 - Digital Effect List.....	26

Digital Piano Set-up Guide

1. Open the package, and check whether the following parts are available:

- | | |
|----------------------------|---|
| 1. Piano body | 6. Foot pedal unit |
| 2. Music stand | 7. Hand screw (4 pcs.) |
| 3. Right leg component | 8. Screws (8 pcs.) |
| 4. Left leg component | 9. Screw caps (8 pcs.) |
| 5. Center supporting board | 10. Power cable stabilizing hook (2 pcs.) |

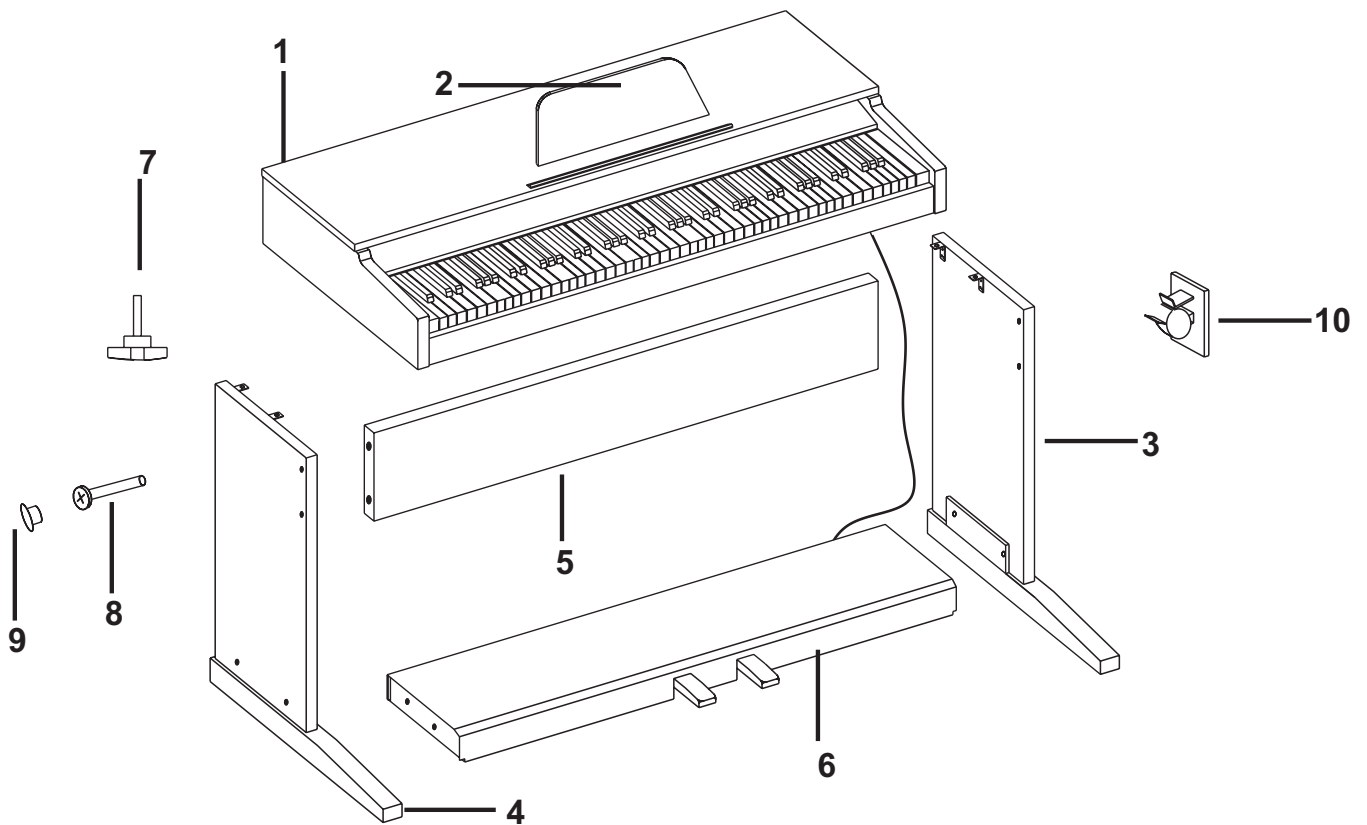

Digital Piano Set-up Guide.....Continued

2. Follow the illustration below and finish off the set-up procedures.

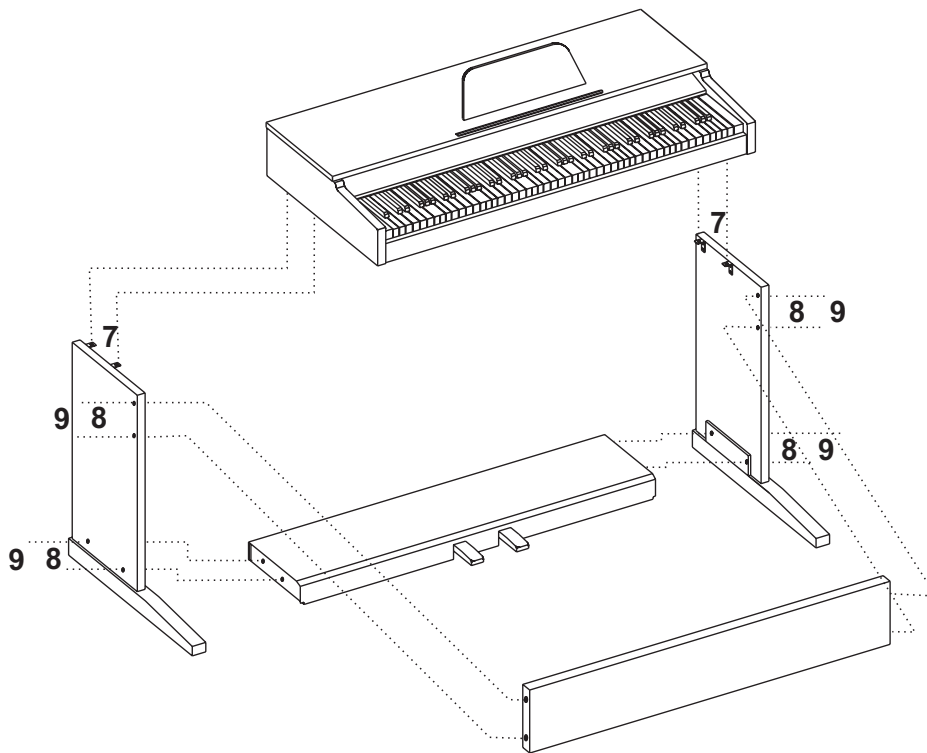

Parts required in this step:

- 7. Hand screws x 4
- 8. Screws x 8
- 9. Screw caps x 8

Caution: When setting up the piano, please use the screws supplied and avoid using the unspecified screws which may damage the piano body or causing the loss of stability.

A. Put the foot pedal unit(6) in between the left and right legs components (3&4), use 4 pieces of screws (2 on each side) to stable the legs onto the foot pedal unit. (Make sure the direction of the placement is correct before screwing)

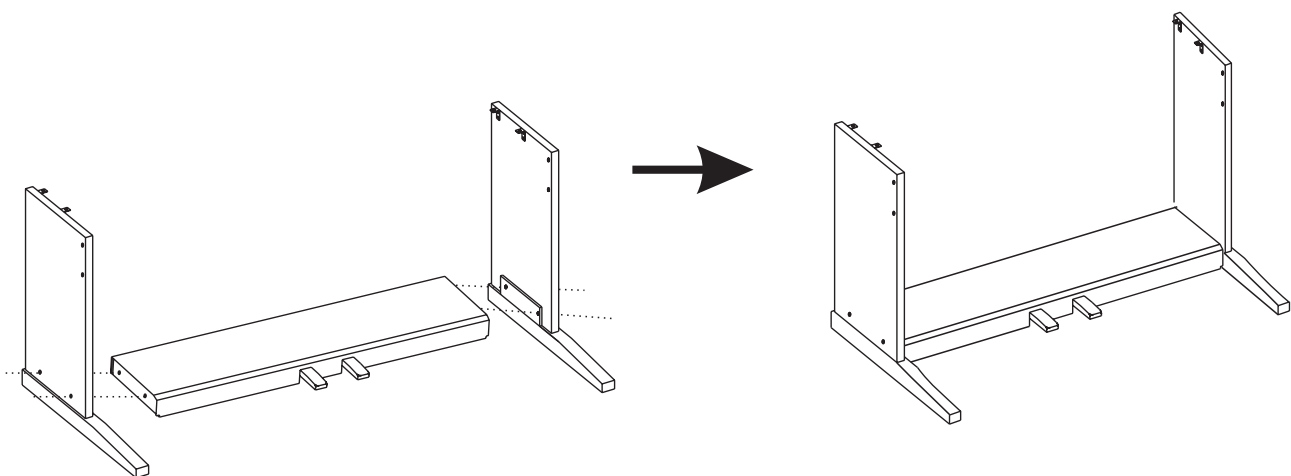

Digital Piano Set-up Guide.....Continued

B. Use 4 pieces of screws (2 on each side) to stable the center supporting board (5) onto the assembly finished in Part A on the previous page.

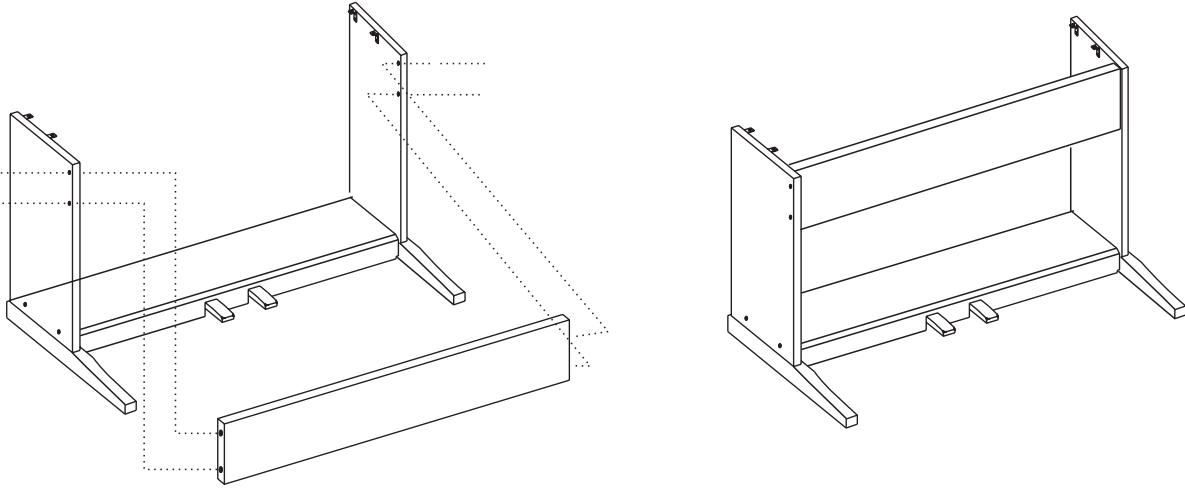

C. Put the piano body(1) on the top of the assembly finished in part B, use 4 pieces of hand screws to stable afterward.

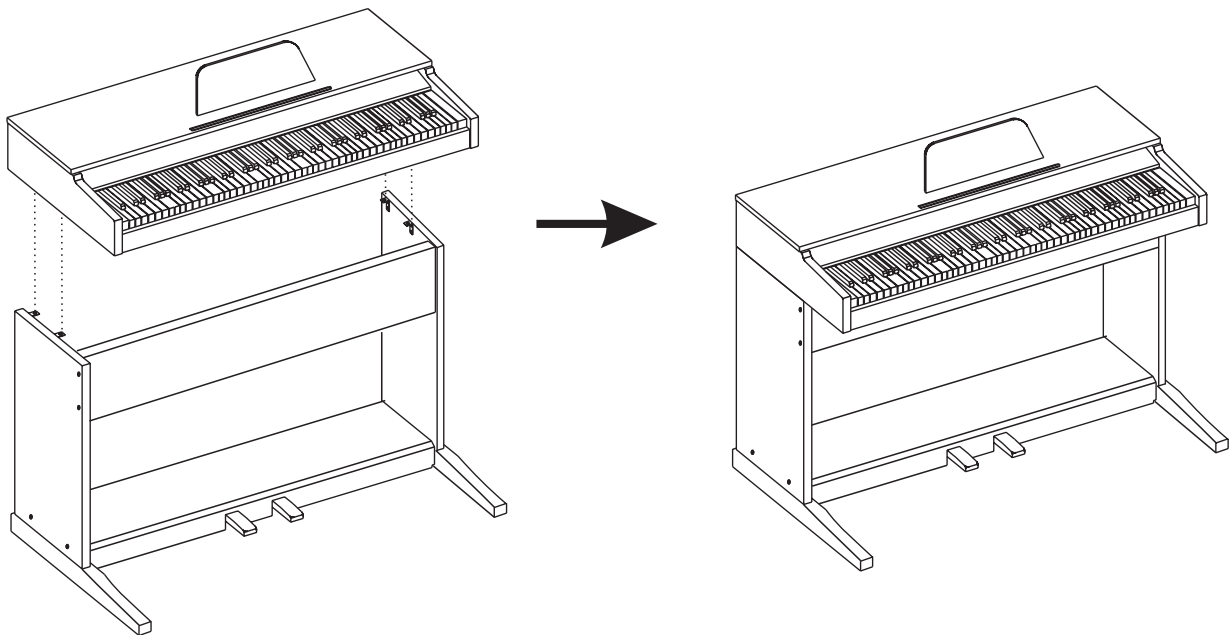

D. After the initial set-up, stick the cable stabling hook(10) on the internal side of the leg component (see the below illustration for reference).

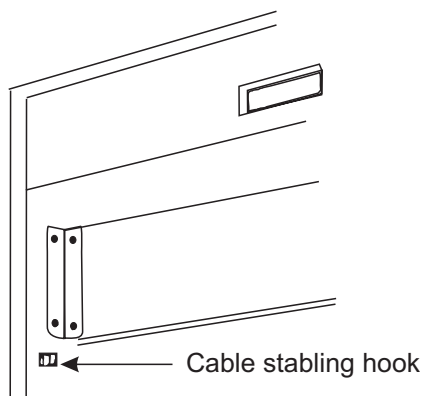

General Guide

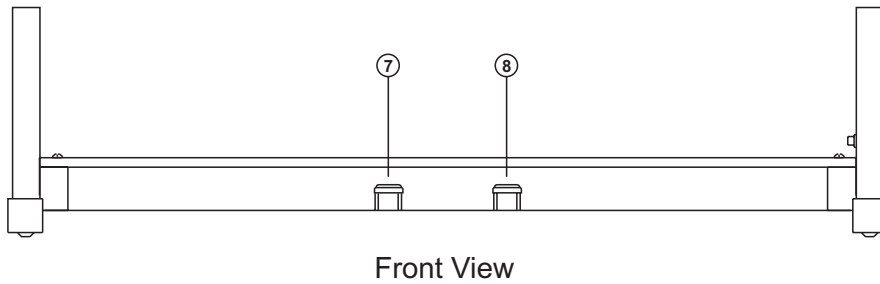
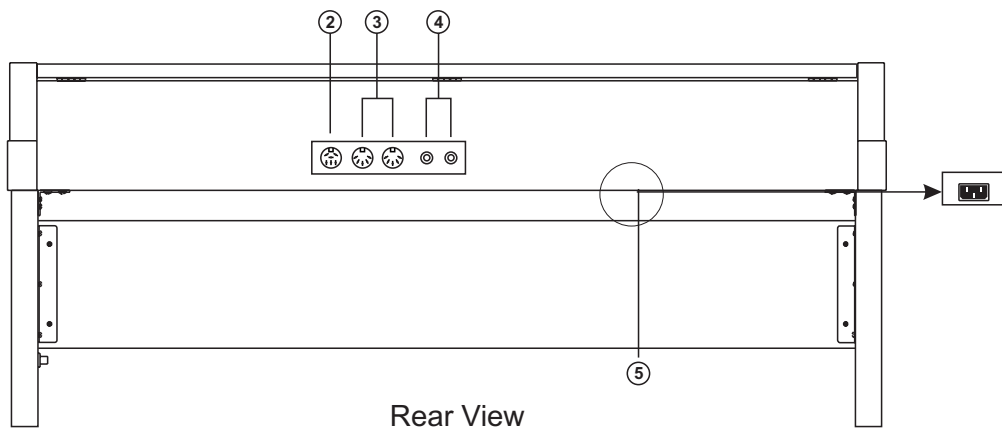
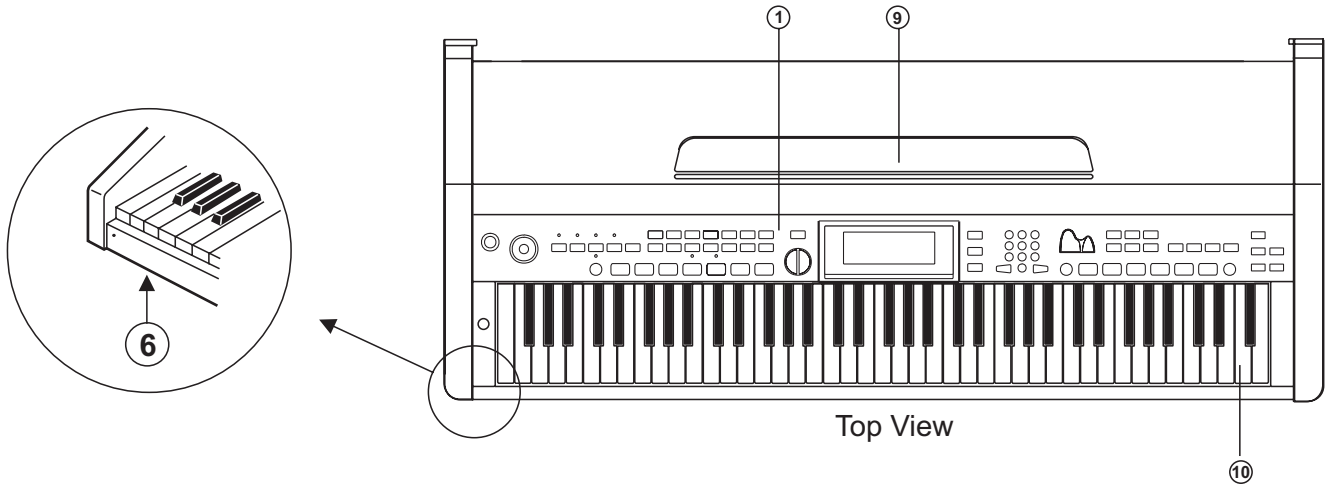

- | | |
|--------------------|-------------------|
| ① Control Panel | ⑥ Headphones Jack |
| ② Pedal Jack | ⑦ Soft Pedal |
| ③ MIDI IN/OUT Jack | ⑧ Sustain Pedal |
| ④ AUX. OUT Jack | ⑨ Music Stand |
| ⑤ AC Power Jack | ⑩ Piano Keyboard |

General Guide.....Continued

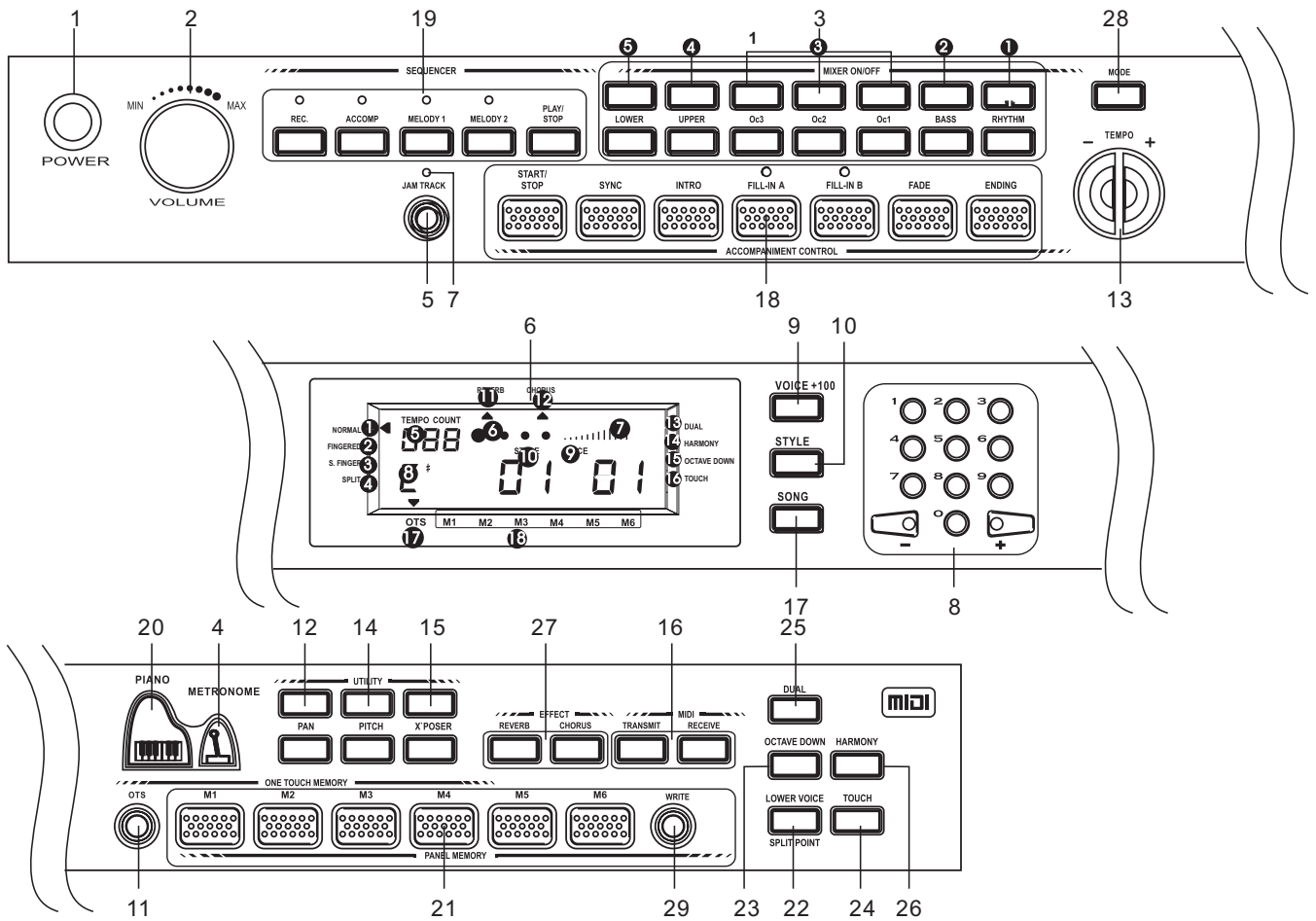

- | | | |
|-----------------------------|-------------------------|----------------|
| ① POWER SWITCH | ⑦ JAM TRACK INDICATOR | ⑳ PANEL MEMORY |
| ② MASTER VOLUME | ⑧ NUMERIC KEYPAD | ㉑ SPLIT |
| ③ MIXER CONTROL | ⑨ VOICE SELECT | ㉒ OCTAVE DOWN |
| - LOWER | ⑩ STYLE SELECT | ㉓ TOUCH |
| - UPPER | ⑪ OTS | ㉔ DUAL |
| - OC1, OC2, OC3 | ⑫ TEMPO +/- | ㉕ HARMONY |
| - BASS | ⑬ PAN | ㉖ EFFECT |
| - RHYTHM | ⑭ PITCH | - REVERB |
| ④ METRONOME | ⑮ X'POSER | - CHORUS |
| ⑤ JAM TRACK | ⑯ MIDI | ㉗ MODE |
| ⑥ LCD DISPLAY | - TRANSMIT | ㉘ WRITE |
| ① - NORMAL | - RECEIVE | |
| ② - FINGERED | ⑰ SONG | |
| ③ - S.FINGER | ⑱ ACCOMPANIMENT CONTROL | |
| ④ - SPLIT | - START/STOP | |
| ⑤ - TEMPO | - SYNC | |
| ⑥ - METRONOME | - INTRO | |
| ⑦ - VOLUME | - FILL-IN A | |
| ⑧ - CHORD | - FILL-IN B | |
| ⑨ - VOICE 1, VOICE 2, LOWER | - FADE | |
| ⑩ - STYLE | - ENDING | |
| ⑪ - REVERB | ⑲ SEQUENCER | |
| ⑫ - CHORUS | - RECORD | |
| ⑬ - DUAL | - ACCOMP | |
| ⑭ - HARMONY | - MELODY 1 | |
| ⑮ - OCTAVE DOWN | - MELODY 2 | |
| ⑯ - TOUCH | - PLAY/STOP | |
| ⑰ - OTS | ㉑ PIANO | |
| ⑱ - MEMORY | | |

The Connectors

Using the AC power jack

1. Connect the power cable to the AC power jack on the underside of the piano body.

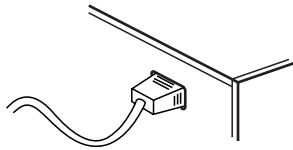

2. Ensure the piano is turned off when connecting and disconnecting the power.

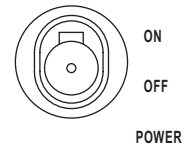

3. Turn the volume switch anti-clockwise to reach the minimum volume level.



4. Plug the power cable into an AC power outlet.

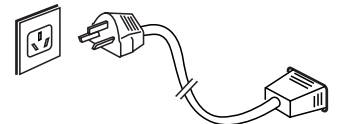

5. If you have done the above procedures you are now safe to turn on the piano.

Caution: When the piano is not in use or during a thunderstorm, disconnect the power for safety sake.

Using Headphones

An optional set of stereo headphones can be connected to the headphones jack located on the left underside of the piano body. When a pair of headphones is connected to the jack, the internal speakers will switch off automatically.



Caution:

- Never use the headphone with high volume, as it may damage your sense of hearing.
- To prevent the damage of the speakers, ensure that the volume is set to the minimum level before connecting the power and other device.

Using the AUX.OUT jack

Connect the rear-panel AUX.OUT jack to amplified speakers, amplifiers or domestic hi-fi-units for external amplification.

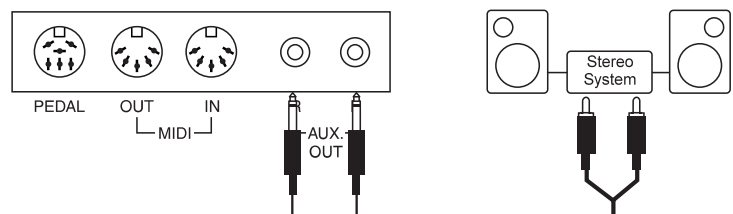

Note: Connect both left(L) and right(R) channels for the stereo result. If you only connect either one of the channels, the connected channel will only take effect.

The Connectors.....Continued

Using the Foot Pedals

Connect the plug of the foot pedal unit to the pedal jack on the rear panel. You will experience the sustain effect.

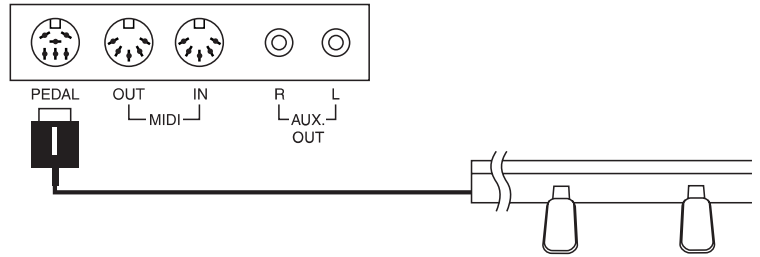

Using the MIDI IN/OUT Jack

MIDI stand for Musical Instrument Digital Interface. MIDI is a world wide standard that makes it possible for various electronic musical instruments and other devices.

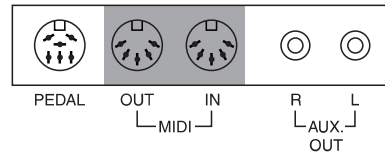

MIDI IN: Data transmitted from other MIDI instrument via MIDI, is received at this terminal.

MIDI OUT: Data produced by the Digital Piano is transmitted to other MIDI instruments via MIDI from this terminal.

Basic Operation

1. Power Switch & Volume

1. Turn the **POWER** switch on.
The LCD display light up.

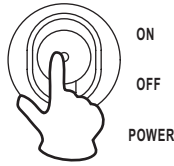

2. Use the volume control switch to adjust the volume to your desired level



- Note:**
- If the LCD display has not light up after you turned on the piano, please check the power supply.
 - If the piano is silent, the volume may be adjusted to its minimum level.

2. Demonstration

This Digital Piano comes with 10 demo songs for showing you the possibilities of the piano. To playback the demo songs, follow the instructions below:

- Press the **SONG** button, the demo song start to playback. There are 10 demo songs and they can play in sequence or in loop.
- When you press the **SONG** button during the playback, the song playing currently will stop and will skip to the next song.
- During the playback you can use the numeric keypad or the "+" and "-" keys to select the songs.
- To stop the playback, press the **START/STOP** button.

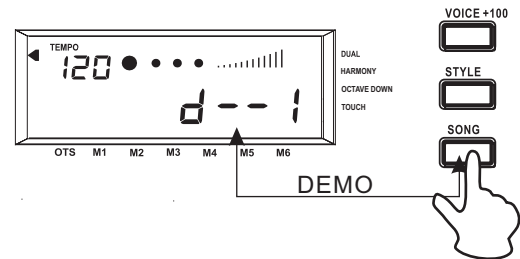

- Note:** During the demo song playback, the digital piano is unable to play.

Voices and Effects

This digital piano features 147 voices which already divided into 18 groups. For the types and names of the voices please see the voice list later in this manual.

1. Select a Voice

- The Voice Select mode is the default mode every time the piano is turned on and VOICE 01 is selected. At this time you can use the numeric keypad or the "+" and "-" keys to select another voice.
- When you are choosing Voice 01-99 at the status of VOICE 1 or VOICE 2, you can use the numeric keypad to input the number of your desired voice directly.
- Three digits voice number are entered by first pressing the **+100** button, then press the remaining two digits in sequence.

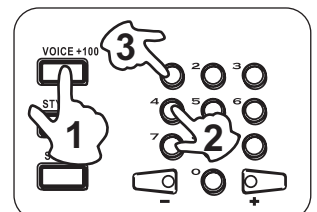
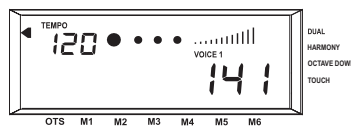
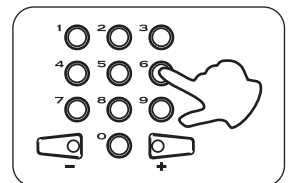
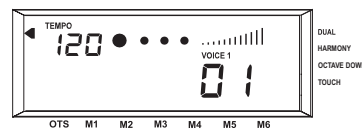

Voices and Effects.....Continued

2. Dual Voice

This digital piano features dual voice option which allow you to hear two different sounds for every note played.

1. When VOICE 1 is showing on the display, press the **DUAL** button, a word VOICE 2 appears in the display. Now input the second voice digits.

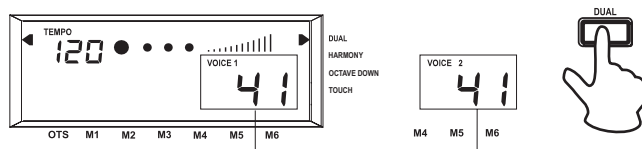

2. Press the **DUAL** button again to turn this function off, and the word VOICE 1 appears in the display.

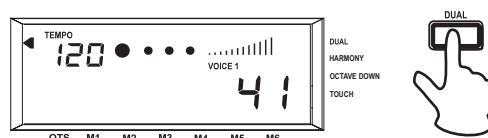

Note: Dual Voice function only working on full keyboard playing or right-hand playing status.

3. Harmony

This digital piano has three different harmony settings, it transforms simple one-note melodies into fully orchestrated pieces.

1. When the piano is turned on, the harmony function is in the off status, press the **HARMONY** button once, then a word OFF appear in the display.

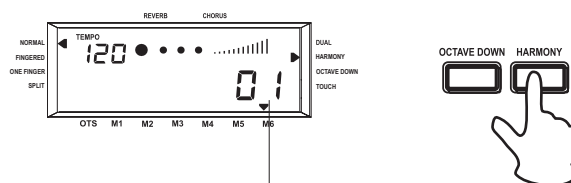

2. When OFF is showing in the display, press **HARMONY** button once, at this time an arrow head points to HARMONY in the display and the harmony value switch from OFF to 01. Now play a key on the left to turn on the auto accompaniment, and play a key on the right to hear the harmony effect.

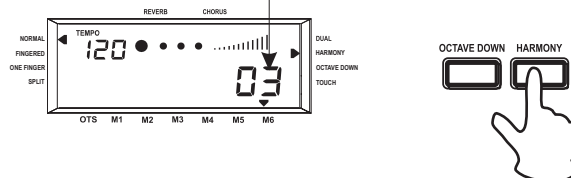

3. When you are in harmony 01 status, press the **HARMONY** button once and 02 will appear in the display. If you would like to switch to harmony 03, press the **HARMONY** button once more. Now play a single note on the right keyboard. If you selected harmony type 01, you will hear two notes play.

Select harmony type 02 and play the same chord and single note again, this time you will hear a three note chord on the right hand for every single note played.

Select harmony type 03 and play the same chord and single note again, this time you will hear an octave intervals for every single note played.

4. To turn off the harmony function, press the **HARMONY** button until OFF appears in the display.

Note: ● If the keys on the left are in Normal or Split mode, the harmony effect will not take effect.

● If the Harmony function is turned on, only play a single note by right hand will take effect.

● During recording, the harmony effect will not work. If you start recording when the harmony function is turned on, the function will turn off automatically.

Voices and Effects.....Continued

4. Drum Kit

This digital piano features 7 percussion sounds.

- Voices 141-147 are the featuring drum set of this digital piano. To select a drum set, please refer to the section "Select a Voice" on page 10.

5. Digital Effects

This digital drum has 8 Reverb and 8 Chorus effects. This function can adjust the reverb and chorus effect by referring to the performing environment.

- Reverb effect

To adjust reverb type and levels:

1. Press the **REVERB** button, then two values appear on the display, the one on the left is reverb type, the other one is the reverb level.
2. Hold the **REVERB** button, the reverb type value start to flash, you can change the reverb type by input number 0-7 with the numeric keypad. When the reverb type is selected, the reverb level start to flash, now you can use the same method as selecting reverb type to select reverb level (0-7).

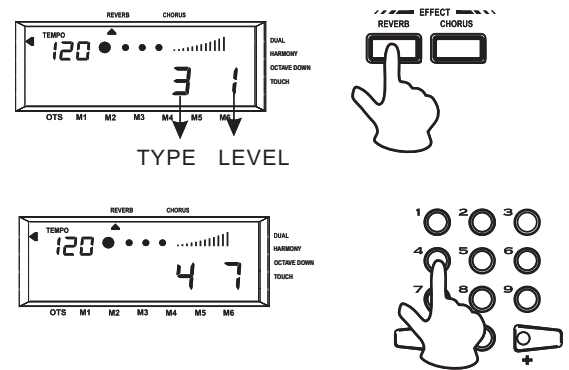

- Chorus effect

To adjust chorus type and levels:

1. Press the **CHORUS** button, then two values appear on the display, the one on the left is chorus type, the other one is the chorus level.
2. Hold the **CHORUS** button, the reverb type value start to flash, you can change the chorus type by input number 0-7 with the numeric keypad. When the chorus type is selected, the chorus level start to flash, now you can use the same method as selecting chorus type to select chorus level (0-7).

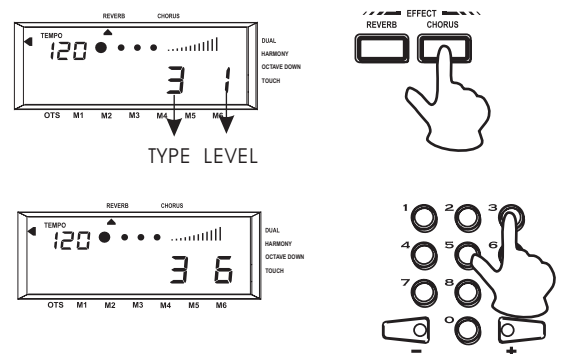

- Note:
- When the Reverb and Chorus levels are set to 0, the effects are turned off.
 - The default Reverb type and level are both set to 4; the default Chorus type and level are both set to 0, as in off status.

Voices and Effects.....Continued

6. Instant select Piano voice

You can select the piano voices immediately by pressing the **PIANO** button.

- When you press the **PIANO** button, the digital piano turns into Normal status automatically, at this time Dual voice function is unable to start.
- Press the **PIANO** button again to exit the PIANO mode and return to the previously selected voice.
- If you select a voice directly in the Piano status, the PIANO status will be exit automatically.

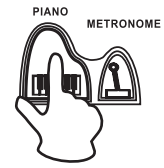

Touch Response Keyboard

The keys on this digital piano is velocity sensitive, which means, the harder you play on the keys, the louder the sound becomes, as occurs in an acoustic piano.

- The Touch Response Keyboard can be turn on and off at any time. At the default, the Touch Response is turned on.
- Press the **TOUCH** button, the arrow head pointing to TOUCH on the display disappears, at this time the touch response is off.

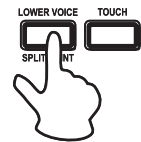
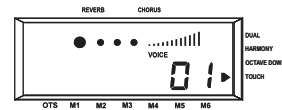

Octave Down Control

When you are playing in Normal mode, you can octave-shift the current voice down one octave in real time. In the Fingered, Single Fingered and Split mode, play with the right hand to shift down one octave.

- In Normal mode, press the **OCTAVE DOWN** button, the octave down indicator appears in the display and now the entire keyboard shift down one octave.
- In Fingered, Single Fingered and Split mode, press the **OCTAVE DOWN** button, the octave down indicator appears in the display and now the right section of the keyboard shift down one octave.
- To cancel the octave down function, press the **OCTAVE DOWN** button again, the octave down indicator turns off.

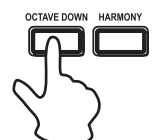
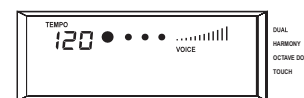
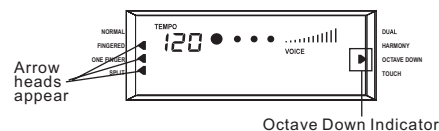
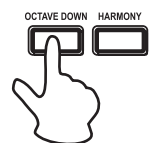
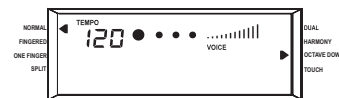

Split Keyboard

To play on a split keyboard with one or two voices on the right section (Upper keyboard) and one voice on the left (Lower keyboard), press the **MODE** button as many times as necessary until the arrowhead points to the **SPLIT** function.

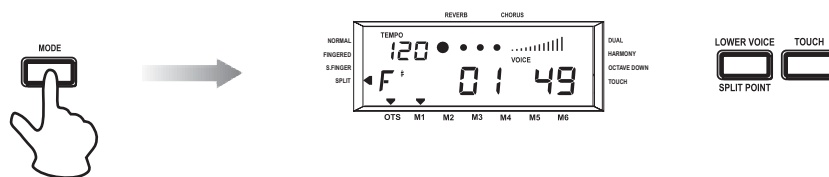

• Select a Split Point

1. Press and hold the **SPLIT POINT** button. The display shows the current Split point setting expressed as a note of the keyboard, together with the number of the Voice assigned to the LOWER section. The default setting corresponds to note F#3. (If you release the **SPLIT POINT** button, the display returns to the previous situation).
2. While still holding the **SPLIT POINT** button, press a key corresponding to the new Split point. (Note: If you use the + or - buttons in this situation, you will change the voice of the Lower section).

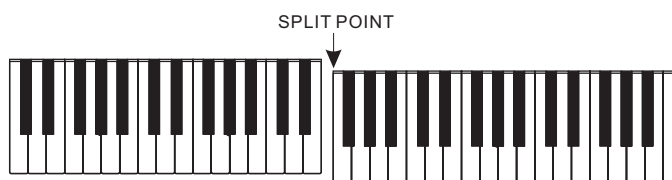

3. To exit the Split mode, press the **MODE** button as many times as necessary until the arrowhead points to **NORMAL**.

• Play in Split mode with a Dual option on the Upper keyboard

To play with two layered sounds on the Upper keyboard and one on the lower simply press the **DUAL** button while you are in **SPLIT** mode.

Note: In the **SPLIT** mode, if you feel the ratio of the Lower and Upper sections does not meet your requirement, you can proceed to further adjustment with the **MIXER CONTROL** function as will describe later in this manual.

Playing the Styles

This digital piano contains 99 styles (01-99) and 1 metronome (00). The sophisticated Auto Accompaniment system can provide automated bass and chord backing that is perfectly matched to the selected accompaniment arrangements.

1. Select a Style

1. Press the **STYLE** button, the message appears in the display.

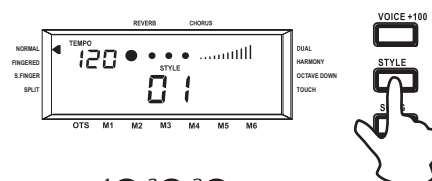

2. Use the **NUMERIC KEYPAD** or the + and - keys to input a Style number.

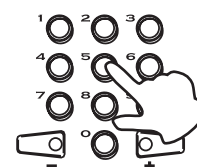

Playing the Styles.....Continued

2. The Chord Recognition Modes

The digital piano allows you to choose between two different Chord modes: Fingered and Single Finger.

- Single Finger mode

1. Choose a style that you desired (01-99).
2. Press the **MODE** button until the arrowhead points to S.Finger.

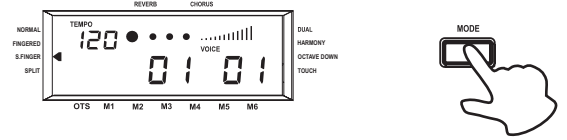

3. Press the **START/STOP** button to start to playback the style.

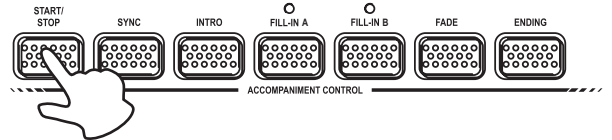

4. Follow the Single Finger Chord table in the appendix section and play the chord that you want.

The following shows C, Cm, C7 and Cm7 as the examples of the S.Finger Chord playing method:

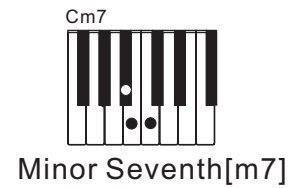
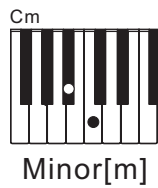
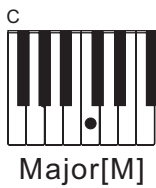

- Fingered mode

In this mode, play the keys on the left of the Split point to play the Fingered Chord that you want.

1. Choose a style that you desired (01-99).
2. Press the **MODE** button until the arrowhead points to Fingered.

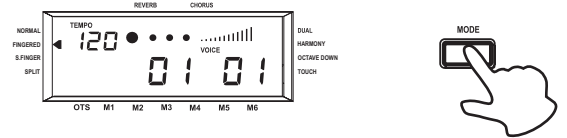

3. Press the **START/STOP** button to start to playback the style.

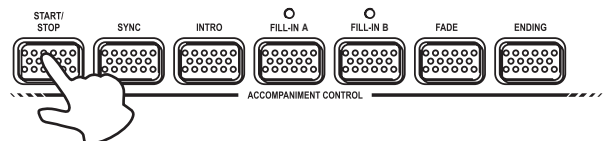

4. Follow the Fingered Chord table in the appendix section and play the chord that you want.

Playing the Styles.....Continued

3. Accompaniment Control

This digital piano provides a wide variety of automatic functions that make itself very easy to play. The functions are found in the Accompaniment Control section.

- **START/STOP**

Press the **START/STOP** button to start/stop the style.

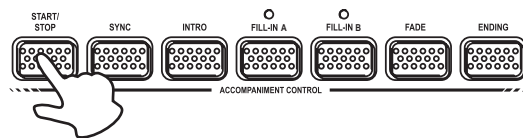

- **SYNC**

1. The SYNC function allows you to synchronize the start of your Style with a note or chord pressed on the keyboard without using the **START/STOP** button. When you press the **SYNC** button, the display shows the beat pattern indicators and the FILL-IN A indicator to indicate the synchro is in standby mode.

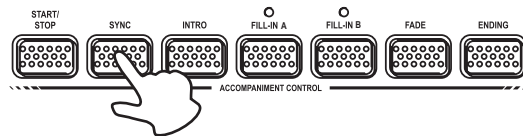

2. If you are in Normal mode, you can start the style by playing any key on the keyboard. If you are in Fingered, S.Finger or Split mode, you have to play the chord that is corresponding to the style pattern you selected.

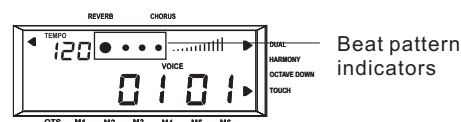

3. To stop the style, press either the **START/STOP** button or the **SYNC** button.

- **INTRO**

Before starting the Style, press the **INTRO** button to place the piano on intro-start standby. The LED of the current Style pattern starts to flash to indicate that the INTRO has been preset. Now press the **START/STOP** button to play a note or chord on the lower part of the piano. The Style starts with an introductory pattern then it proceeds with the selected auto-accompaniment.

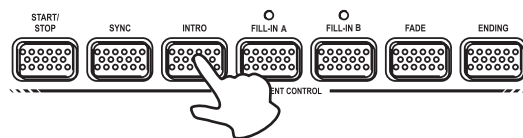

- **FILL in A/B**

FILL-IN A is the normal situation of the styles, all the 99 styles in the piano are playing in this situation. FILL-IN B is the situation that adds variations to FILL-IN A.

When you press the **FILL-IN A** or the **FILL-IN B** during playback, the current pattern is interrupted by an appropriate Fill-in, then it proceeds with the same pattern, depending on which button you press.

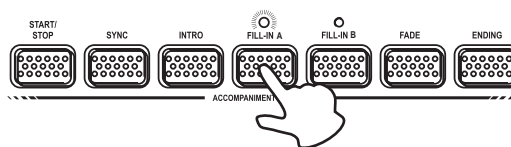

- **FADE**

While playing your style, you can fade the overall volume down simply by pressing the **FADE** button. After pressing the button, the Style continues to play but the volume decreases gradually until no volume is heard.

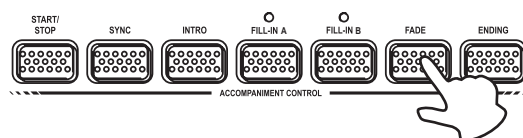

Playing the Styles.....Continued

- ENDING

You can stop your Style automatically with a well-executed ending pattern without using the **START/STOP** button. While the Style is playing, simply press the **ENDING** button. The Style auto-accompaniment stops automatically with an Ending phrase.

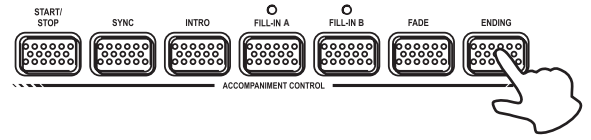

Metronome

At any time, you can activate the METRONOME for practising purposes.

1. To play with the Metronome, press the **STYLE** button and insert the value "00".
2. Press the **START/STOP** button to start the Metronome. You can choose the metronome type (0,2-9) by pressing the **METRONOME** button.
3. When the Metronome is playing, you can adjust the speed by pressing the **TEMPO +/-** buttons.
4. To stop the Metronome, press the **START/STOP** button.

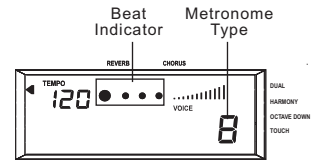
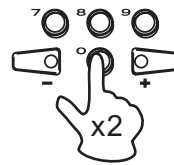

Jam Track

1. While the electronic keyboard is playing the auto-accompaniment, you press the **JAM TRACK** button and the indicator lights up. In this case, the electronic keyboard will play the chord of the style according to the previous setting. Press the **JAM TRACK** button again, the JAM TRACK indicator turns off, and the electronic keyboard will return to normal-mode.
2. In the JAM TRACK accompaniment pattern by pressing the **FILL-IN A** or the **FILL-IN B** button, the JAM TRACK function will cancel automatically.

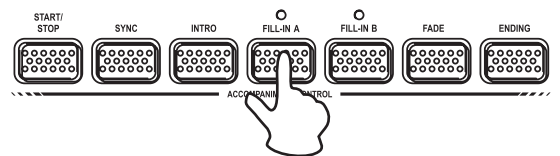

One Touch Setting

The One Touch Setting is a quick and easy way of reconfiguring voices of Upper and Lower sections of a style by pressing only one button while you are playing.

Selecting the One Touch Setting

1. Select a Style using the methods already described.
2. Press the **OTS** button. The display shows an arrowhead pointing to the OTS indicator. Make sure one of the two chord recognition mode is selected.
3. Press the **START/STOP** button to play the selected style. While playing the style, you can press one of the **ONE TOUCH SETTING** buttons--[M1], [M2], [M3], [M4] to select the appropriate setting.

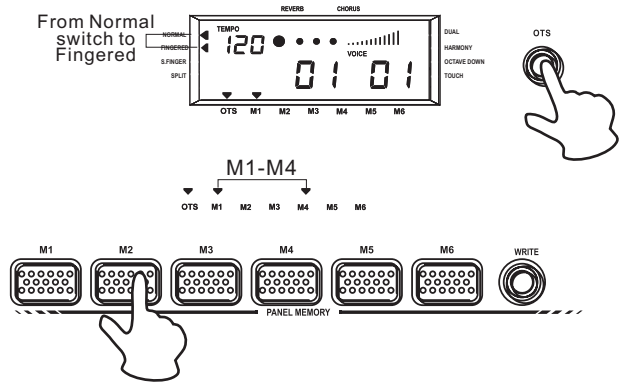

Memorize Panel Settings

If you don't want to use the factory style settings, you can memorize your own panel configurations to the **MEMORY** buttons. This function allows you to store up to 6 user-defined configurations, including Style, Variation and other selections, which you can then recall by simply pressing a button.

How to store a memorized setting?

You are able to store the following values into your user-define settings:

1. Voice values
 - Voice Variation setting
 - Mixer Control setting
 - Touch Response On/Off
 - Reverb, Chorus and Level setting
 - Harmony effect setting
 - Octave Down setting
 - Split Keyboard setting
2. Accompaniment values
 - Accompaniment style number
 - Mixer Control setting
 - FILL-IN A/B setting
 - Intro, Ending, Fade setting
 - Split Point setting
3. Tempo setting
 - Mode configuration (Normal, Fingered, Single Finger, Split Keyboard)

You only need to change one aspect of any factory setting to be able to save as a new setting.

1. Press the **STYLE** button, then press the **OTS** button, use the numeric keypad or the **+/-** keys to choose a style.
2. Press the **VOICE** button and select a different voice by using either the numeric keypad or the **+/-** keys.
3. Press the **OTS** button to deactivate the OTS function.
4. Hold down the **WRITE** button and press one of the **MEMORY** button (M1-M6). An arrowhead at the bottom of the display shows the current memorized setting.

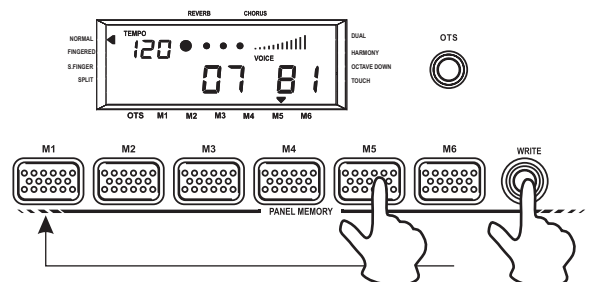

The Sequencer

The digital piano has a 3 tracks recording function, you can record in Voice mode or Style mode with one or two melody tracks. In the playback, you can play along with the recorded sequence using different voices to those used in the Melody tracks.

1. Set the piano to STYLE mode and select a Style.
2. Press the **RECORD** button. The LED of the RECORD button starts to flash and the KEY START function activates automatically (the Beat indicators start to flash).

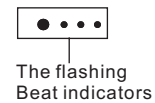

3. Press the **ACCOMP** button followed by the **MELODY 1** button. This allows you to record a melody line with auto accompaniments. The LED of the ACCOMP and MELODY 1 buttons start to flash to indicate that the tracks are ready to record.

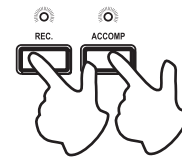

4. Start to record the notes you play. The Key Start function triggers the Style accompaniment patterns when you play a chord on the keyboard below the split point.
5. While playing, use the FILL-IN buttons to change the Variations, change Voices for the Upper and Lower sections, activate Dual Mode, etc. Your actions will be captured by the sequencer.
6. To stop the recording, press the **RECORD** button and the LED will turn off. At this point you will have a recorded sequence consist of a melody line with accompaniment. You can record the Melody 2 track or leave it empty, according to your requirements. To record the Melody 2 track, press the **RECORD** button, then press the **MELODY 2** button. Start the recording by playing the keyboard.

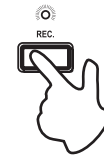

Playback the recorded song

Press the **PLAY/STOP** button to listen to the playback of your recorded song. Before starting, you can deactivate one or more recorded tracks. For example, if you have recorded the ACCOMP and MELODY 1 tracks, you can deactivate the Melody 1 track to playback the Accomp track only.



Record a New Song

To record a new song and cancel the old one, simply press the **RECORD** button and the buttons of the track you want to record. For example, if the **ACCOMP** and **MELODY 1** buttons already contain recorded notes (LEDs on), press the **RECORD** button, then press the **ACCOMP** and **MELODY 1** buttons. All LEDs start to flash indicating that the sequencer is set to record mode. Proceed to record your new song using the methods already described. The old song is overwritten by the new one.

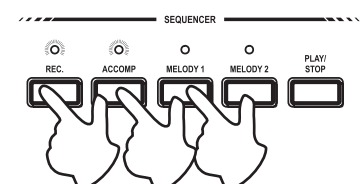

Mixer Volume Control

If you are playing in Normal mode with Voices on a Split keyboard, you may at some stage want to adjust the volume of one section with respect to the other. Using the MIXER Volume controls, you can balance your Upper and Lower voices to the levels requires easily.

The mixer consist of 7 twin buttons organized in 2 rows. The top row of buttons are INCREASE VOLUME controls while the bottom row are DECREASE VOLUME controls.

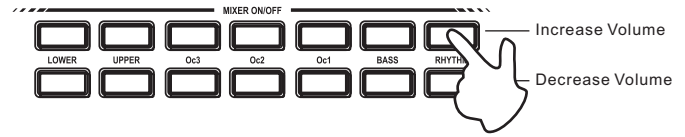

To increase the volume of each section, press and hold the **INCREASE VOLUME** button on the top row until you reach the volume you required.

To decrease the volume, press and hold the **DECREASE VOLUME** control button.

Muting the sections

You can use the MIXER control buttons to turn off a section, simply press both INCREASE VOLUME and DECREASE VOLUME buttons simultaneously to mute te section required.

To restore the volume to normal, press both the **INCREASE VOLUME** and **DECREASE VOLUME** buttons again at the same time.

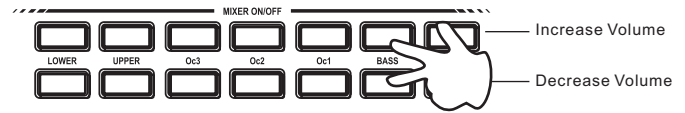

Utility Functions

Changing the Tempo

Every time you select a Style, you also recall a memorized Tempo, shown on the top left corner of the display.

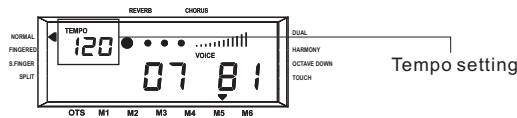

You can speed up or slow down the tempo, before or after starting the Style by pressing the **TEMPO +/-** buttons. Hold down either the + or - button to change the Tempo value at high speed.

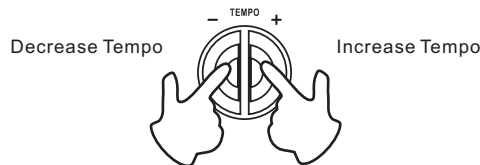

Restoring the memorized Tempo

To restore the Style's memorized tempo, press both the **Tempo +** and - buttons simultaneously.



Utility Functions.....Contiuned

Pan

The Pan function allows you to change the stereo pan position of the overall sound, moving the sound at the speakers either to the left or to the right.

If you press either the **INCREASE** or **DECREASE PAN** button once, the display will show the normal setting corresponding to Pan at the center (00).

Press the **INCREASE** or **DECREASE PAN** repeatedly to pan the overall sound to the left (max:07) or to the right (max:07).

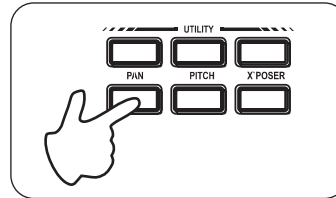
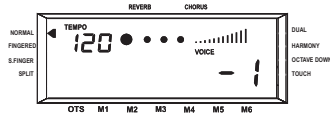

To restore the normal Pan position (00), press both the **INCREASE** and **DECREASE PAN** buttons simultaneously.

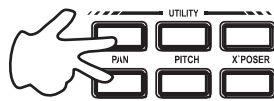

Pitch

The Pitch function allows you to fine tune the instrument.

Press the **INCREASE** or **DECREASE PITCH** buttons repeatedly to raise (max:50) or lower (min:50) the tuning until you reach the value required.

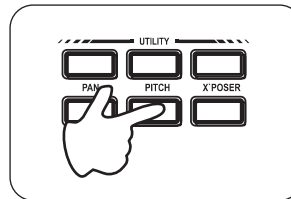
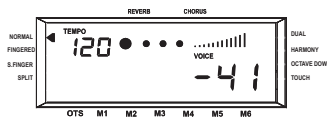

To restore the normal Pitch position (00), press both the **INCREASE** and **DECREASE PITCH** buttons simultaneously.



Transpose

The TRANSPOSE function allows you to change the pitch of the instrument in semi-tone steps, up to a maximum setting of 12 semitones above or below standard pitch.

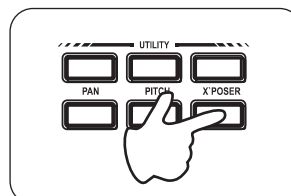
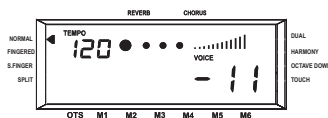

To restore the normal Transpose position (00), press both the **INCREASE** and **DECREASE TRANSPOSE** buttons simultaneously.



MIDI

The MIDI section consists of two functions, TRANSMIT or RECEIVE, which allows you to set the Transmission and Reception channels independently for the keyboard as a whole. Both Reception and Transmission channels also feature a Control Change filter (on/off).

MIDI channel selection

You can set the MIDI Transmission and Reception channels to any value from 1-16, or off.

If you press the **MIDI TRANSMIT** button, the display shows the factory-set MIDI Transmission channel.

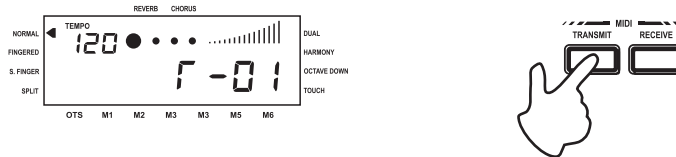

If you press the **MIDI RECEIVE** button, the display shows the factory-set MIDI Reception channel.

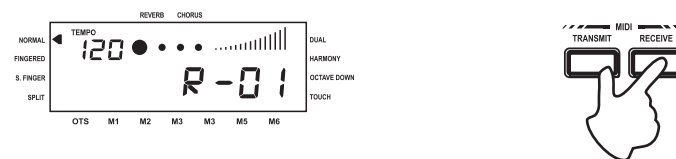

Use the + button in the numeric keypad to increase the Transmission or Reception channel, or the - button to decrease it.



Control Change filter

To set the Control Change filter for either the Transmission or Reception channel, press the **TRANSMIT** or **RECEIVE** button twice. The display shows the current setting (Off).

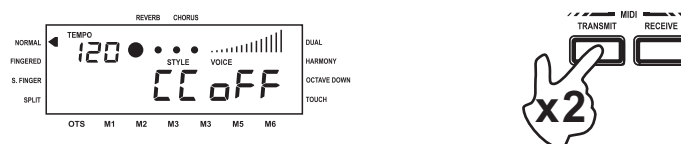

To activate or deactivate the filter, use the + or - buttons of the numeric keypad.

Specifications

Keyboard	88 weighted/hammer action keys
Voice	147 Voices
Style	99 Styles + 1 Metronome
Demo Song	10 Demo Songs
Max, Polyphony	38-note Polyphony (max)
Display	Multi functional LCD display with blue backlit
Switch and Buttons	POWER SWITCH, VOLUME SWITCH, DUAL, OTS, VOICE, STYLE, DEMO, TOUCH, UPPER, LOWER, OC1, OC2, OC3, BASS, RHYTHM, OCTAVE, TEMPO, SELECT, NUMERIC KEYPAD, SPLIT, PAN, PITCH, X'POSER, MODE, HARMONY, REVERB, CHORUS, WRITE, PANEL MEMORY 1-6
Accompaniment Control	START/STOP, SYNC, INTRO/ENDING, FILL-IN A, FILL-IN B, FADE
Sequencer	RECORD, MELODY 1/2, ACCOMP, PLAY/STOP
Panel Memory	6 Memory Storage
MIDI	TRANSMIT, RECEIVE, 1-6 MIDI TERMINALS
Connectors	DC POWER, HEADPHONES, AUX.OUT, MIDI IN/OUT, 2 PEDALS
Voltage	120V
Speaker	8ohm 25w x 2
Dimension	1380 x 520 x 830
Weight	62kg

































Troubleshooting

PROBLEM	CAUSE	SOLUTION
No keyboard sound and LCD display has not light up.	<ol style="list-style-type: none"> 1. Power supply problem 2. Power is not turned on. 	<ol style="list-style-type: none"> 1. Correctly attach the power cable. 2. Set the power switch to ON position.
No keyboard sound but LCD display light up.	<ol style="list-style-type: none"> 1. The volume level is set to the minimum level. 2. Headphones are inserted into the jack. 	<ol style="list-style-type: none"> 1. Adjust the volume to a higher level. 2. Disconnect the headphone from the headphone jack.
The START/STOP button is pressed to start a style, the Beat indicators appear in the display, but no sound.	<ol style="list-style-type: none"> 1. The volume level is set to the minimum level. 2. The RHYTHM in the MIXER Volume Control is too low or has been muted. 	<ol style="list-style-type: none"> 1. Adjust the volume to a higher level. 2. Adjust the RHYTHM track to a higher level, if there is still no sound, press both the INCREASE and DECREASE volume buttons of the RHYTHM track to re-open it.
There is no sound output from the external amplifier speakers or the sound is mono.	<ol style="list-style-type: none"> 1. The volume level is too low. 2. Only either one of the left or right channel is connected. 	<ol style="list-style-type: none"> 1. Adjust the volume to a higher level. 2. Connect both the left(L) and right(R) channels for the stereo result.

Appendix 1A - Single Finger Chord Chart

	Chord Name [Abbreviation]	Normal Voicing	Chord	Display
0	Major[M]	1-3-5	C	C
1	Major sixth [6]	1-(3)-5-6	C6	C6
2	Major seventh [M7]	1-3-(5)-7	CM7	CM7
3	Major seventh sharp Eleventh [M7#11]	1-(2)-3-#4-(5)-7	CM7#11	CM7#11
4	Major add ninth [Madd9]	1-2-3-5	Cmadd9	Cm(9)
5	Major ninth [M9]	1-2-3-(5)-7	Cm9	CM7(9)
6	Major sixth add ninth [6 9]	1-2-3-(5)-6	C6 9	C6(9)
7	augmented [aug]	1-3-#5	Caug	Caug
8	Minor [m]	1-b3-5	Cm	Cm
9	Minor sixth [m6]	1-b3-5-6	Cm6	Cm6
10	Minor seventh [m7]	1-b3-(5)-b7	Cm7	Cm7
11	Minor seventh flatted fifth [m7b5]	1-b3-b5-b7	Cm7b5	Cm7b5
12	Minor add ninth [madd9]	1-2-b3-5	Cmadd9	Cm(9)
13	Minor ninth [m9]	1-2-b3-(5)-b7	Cm9	Cm7(9)
14	Minor eleventh [m11]	1-(2)-b3-4-5-(b7)	Cm11	Cm7(11)
15	Minor major seventh [mM7]	1-b3-(5)-7	CmM7	CmM7
16	Minor major ninth [mM9]	1-2-b3-(5)-7	CmM9	CmM7(9)
17	Diminished [dim]	1-b3-b5	Cdim	Cdim
18	Diminished seventh [dim7]	1-b3-b5-6	Cdim7	Cdim7
19	Seventh [7]	1-3-(5)-b7	C7	C7
20	Seventh suspended Fourth [7sus4]	1-4-5-b7	C7sus4	C7sus4
21	Seventh flatted Fifth [7b5]	1-3-b5-b7	C7b5	C7b5
22	Seventh Ninth [79]	1-2-3-(5)-b7	C7 9	C7(9)
23	Seventh sharp eleventh [7#11]	1-2-3-#4-(5)-b7 or 1-(2)-3-#4-5-b7	C7#11	C7(#11)
24	Seventh thirteen [7 13]	1-b2-3-(5)-b7 or 2-3-5-6-b7	C7 13	C7(13)
25	Seventh flatted Ninth [7b9]	1-b2-3-(5)-b7	C7b9	C7(b9)
26	Seventh flatted Thirteen [7b13]	1-3-5-b6-b7	C7b13	C7(b13)
27	Seventh sharp ninth [7#9]	(1)-#2-3-(5)-b7	C7#9	C7(#9)
28	Major Seventh augmented [M7aug]	1-3-#5-7	CM7aug	CM7aug
29	Seventh augmented [7 aug]	(1)-3-#5-b7	C7aug	C7aug
30	Suspended Fourth [sus4]	1-4-5	Csus4	Csus4
31	One plus two plus five [1+2+5]	1-2-5	C1+2+5	C

Appendix 1B - Fingered Chord Chart

0 C 	1 C ₆ 	2 C _{M7} 	3 C _{M7} (#11) 	4 C(9) 	5 C _{M7} (9) 	6 C ₆ (9) 	7 C _{aug} 
8 C _m 	9 C _{m6} 	10 C _{m7} 	11 C _{m7} ^{b5} 	12 C _m addg 	13 C _{m7} (9) 	14 C _{m7} (11) 	15 C _m M ₇ 
16 C _m M ₇ (9) 	17 C _{dim} 	18 C _{dim7} 	19 C ₇ 	20 C ₇ _{sus4} 	21 C ₇ ^{b5} 	22 C ₇ (9) 	23 C ₇ (9) 
24 C ₇ (^b 13) 	25 C ₇ (^b 9) 	26 C ₇ (¹³) 	27 C ₇ (#9) 	28 C _{M7} _{aug} 	29 C ₇ _{aug} 	30 C _{sus4} 	31 C ₁₊₂₊₅ 

Appendix 2 - Style List

100 STYLES							
ROCK 1	15 R & B 3	29 DANCE FUNK	44 HOUSE 1	59 DIXIE	73 WALTZ 2	87 POP GROOVE 3	
01 8 BEAT 1	16 SOUL ROCK	30 POP SHUFFLE	45 HOUSE 2	60 FOXTROT	74 POP WALTZ	88 POP GROOVE 4	
02 8 BEAT 2	17 6/8 GOSPEL	31 16 BEAT 1	46 EUROBEAT 1	LATIN	75 MARCH 1	89 SPICE GROOVE 1	
03 8 BEAT 3	18 6/8 ROCK	32 16 BEAT 2	47 EUROBEAT 2	61 BOSSA NOVA 1	76 MARCH 2	90 SPICE GROOVE 2	
04 8 BEAT 4	19 SLOW ROCK 1	33 16 BEAT 3	48 DANCE 1	62 BOSSA NOVA 2	77 POLKA	ORIENTAL	
05 8 BT RK 1	20 SLOW ROCK 2	34 16 BEAT 4	49 DANCE 2	63 MAMBO	78 COUNTRY 1	91 ORIENTAL 1	
06 8 BT RK 2	ROCK 2	35 SOUL 1	50 FUSION	64 CHA-CHA	79 COUNTRY 2	92 ORIENTAL 2	
07 8 BT RK 3	21 ROCK SHUFFLE	36 SOUL 2	JAZZ & SWING	65 RHUMBA	80 COUNTRY B	93 ORIENTAL 3	
08 ROCK	22 B BOOGIE	37 SOUL 3	51 SWING 1	66 TANGO	81 COUNTRY R	94 ORIENTAL 4	
09 HVY METAL	23 BOOGIE W	DANCE & POP	52 SWING 2	67 BEGUINE	82 BLUEGRASS	95 ORIENTAL 5	
10 BALLAD 1	24 ROCK'n'ROLL 1	38 DISCO 1	53 SWING 3	68 SAMBA	83 REGGAE	96 ORIENTAL 6	
11 BALLAD 2	25 ROCK'n'ROLL 2	39 DISCO 2	54 BIG BAND 1	69 POP SAMBA	DRUM & BASS	97 DANCLUT	
12 BALLAD 3	26 50'S ROCK	40 DISCO ROCK	55 BIG BAND 2	70 SALSA	84 HOUSE GROOVE	98 KERONCONG	
R & B	27 TWIST	41 POP 1	56 JAZZ BLD	71 LATIN	85 POP GROOVE 1	99 POP MALAY	
13 R & B 1	28 CHARLEST	42 POP 2	57 JAZZ BLD	FOLK	86 POP GROOVE 2	00 METRONOME	
14 R & B 2	FUNK & SOUL	43 P SWING	58 RAGTIME	72 WALTZ 1			

Appendix 3 - Voice List

147 VOICES						
PIANO	22 ACCORDION	43 CELLO	REED	86 VOICE	106 BANJO	127 APPLAUSE
01 PIANO 1	23 HARMONICA	44 CONTRABS	65 S SAX	87 FIFTHS	107 SHAMISEN	128 GUNSHOT
02 PIANO 2	24 TG ACCORDION	45 TREMOLO	66 A SAX	88 BASS	108 KOTO	CHINESE
03 PIANO 3	GUITAR	46 PIZZICATO	67 T SAX	PIANO	109 KALIMBA	129 PIPA
04 HONKY	25 NYLON	47 HARP	68 B SAX	89 NEW AGE	110 BAGPIPE	130 YUE QIN
05 E. PIANO 1	26 STEEL	48 TIMPANI	69 OBOE	90 WARM	111 FIDDLE	131 ZHONGRUAN
06 E. PIANO 2	27 JAZZ	ENSEMBLE	70 EN HORN	91 POLYSYNTH	112 SHANAI	132 GUZHENG
07 HARPSI	28 CLEAN	49 STRINGS 1	71 BASSOON	92 CHOIR	PERCUSSIVE	133 YANGQIN
08 CLAVI	29 MUTED GT	50 STRINGS 2	72 CLARINET	93 BOWED	113 TINKLE BELL	134 ERHU
MALLET	30 OVERDRIVEN	51 SYNTHSTRS 1	PIPE	94 METALLIC	114 AGOGO	135 GAOHU
09 CELESTA	31 DISTORTION	52 SYNTHSTRS 2	73 PICCOLO	95 HALO	115 STEELDRM	136 HI-SUONA
10 GLOCKEN	32 HARMONICS	53 CHOIR AAH	74 FLUTE	96 SWEEP	116 WOODBLOK	137 LUSHEN
11 MUSIC BOX	BASS	54 VOXOOH	75 RECORDER	EFFECTS	117 TAIKODRM	138 QUDI
12 VIBRAPH	33 AC BASS	55 SYNVOX	76 PANFLUTE	97 RAIN	118 MELODTOM	139 BANGDI
13 MARIMBA	34 FINGER	56 ORCH HIT	77 BOTTLE	98 SOUNDTRACK	119 SYNDROM	140 XIAO
14 XYLOPHONE	35 PK BASS	BRASS	78 SHAKU	99 CRYSTAL	120 REVERSE	DRUM SET
15 TUBE BELLS	36 FRETLESS	57 TRUMPET	79 WHISTLE	100 ATMOSPHERE	SOUND EFFECTS	141 STD DRUM
16 DULCIMER	37 SLAP 1	58 TROMBONE	80 OCARINA	101 BRIGHTNESS	121 GT FRET NOIZ	142 ROCK DRUM
ORGAN	38 SLAP 2	59 TUBA	LEAD	102 GOBLINS	122 BREATHNOIZ	143 EL DRUM
17 ORGAN 1	39 SYNBBASS 1	60 MUTED TRP	81 SQUARE	103 ECHOES	123 SEASHORE	144 TR808 DRUM
18 ORGAN 2	40 SYNBBASS 2	61 FR HORN	82 SAWTH	104 SCI-FI	124 BIRD TWEET	145 BRUSH DRUM
19 ORGAN 3	STRINGS	62 BRASS	83 CALLIOPE	ETHNIC	125 TELEPHONE	146 ORCH DRUM
20 CHURCH	41 VIOLIN	63 SYNBRASS 1	84 CHIFF	105 SITAR	126 HELICOPTER	147 ORIENTAL DRUM
21 REED ORG	42 VIOLA	64 SYNBRASS 2	85 CHARANG			

Appendix 4 - Demo Song List

- | | |
|---|-----------------|
| 1. Piano Concerto (by P. T. Tschaikowsky) | 6. Swan Lake |
| 2. Yellow River | 7. Modern Jazz |
| 3. Rock 'N' Roll | 8. Very Happy |
| 4. Jasmine | 9. Jazz |
| 5. Seashore | 10. Last Flower |

Appendix 5 - Digital Effect List

REVERB TYPE		CHORUS TYPE		RECOMMENDED	
0	ROOM 1	0	CHORUS 1	00 24	DISCO
1	ROOM 2	1	CHORUS 2	00 54	SQUARE
2	ROOM 3	2	CHORUS 3	14 00	ROOM
3	HALL 1	3	CHORUS 4	24 64	CHURCH
4	HALL 2	4	FEEDBACK	34 00	HALL
5	PLATE	5	FLANGER	44 00	LARGE HALL
6	DELAY	6	SHORT DELAY	44 64	STADIUM
7	PANNING	7	FEEDBACK DELAY	44 74	ROCK
				54 64	JAZZ
				74 00	FOREST
				74 74	VALLEY

Reverb: 1st Digit - Reverb Type
2nd Digit - Reverb Level

Chorus: 1st Digit - Chorus Type
2nd Digit - Chorus Level

